

U1: 440V-50/6HZ
 U1: 400V-50/6HZ

LINEA TRIFASICA

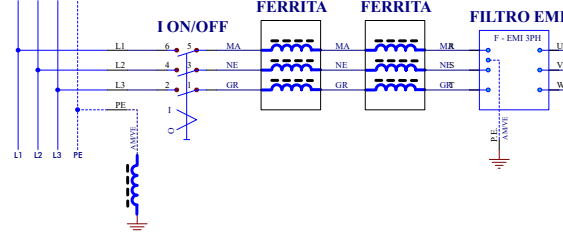

SELECTOR PLACA ALIMENTACION 400V / 440V
 440V O —O—
 400V O—O— O

POTENCIA 98.43

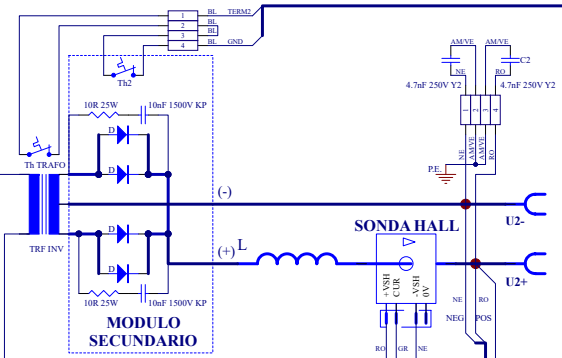

CN 19V H - REMOTE

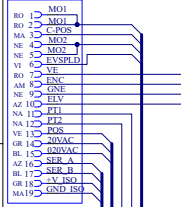

(*1)KIT TELENET
 CN 12V H INTERFACE

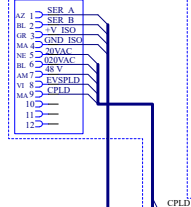

ALIMENTACION GPS4000D

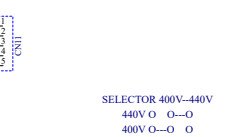

SELECTOR 400V-440V
 440V O —O—
 400V O—O— O

CN12V F REFR

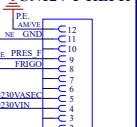

DRIVER PRIMV1

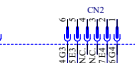

DSP 98.48

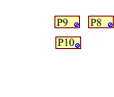

WIRE FEEDER 98.36



ADAPTADOR CONECTOR V1



PLACA FRENTE

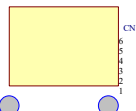

TELENET

TECLADO TFT

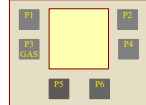

REFERENCIAS GPS 4000 DR ADVANCED:

-GPS 4000 DR ADVANCED:
 42381200 (400V)
 42355200 (440V)

-SYNERBOT 4000 DR ADVANCED:
 42393200 (400V) (*1)
 42394200 (440V) (*1)

(*1)- INCLUYE TELENET



Realizado	27/11/2020	D. MARTIN
Revisado	27/11/2020	A. SERRANO
Aprobado	27/11/2020	J. SIMON
Tamaño	A2	

Fecha	27/11/2020	Nombre	D. MARTIN
Título	GPS 4000 DR ADVANCED		

	GALA GAR ZARAGOZA
Página	1 de 1
Código	EE-42381200
Revision	V1

Revision: V1